

جهاز شئون البيئة
المشروع المصرى للحد من التلوث

دليل التفتيش
الصناعات المعدنية الثانوية

مارس ٢٠٠٢

-

-

-

-

- -

- -

- -

- -

-

- -

- -

- -

- -

- -

- -

-

- -

- -

- -

-

-

-

-
-
-
-
-
-
-
-
-
-
-
-
-
-
-
-
-
-
-
-
-
-

-
-
-
-
-
-

:

FINIDA

:

Õ

•

Õ

Õ

Õ

•

Õ

•

Õ

•

Õ

.(EPAP- GIM 2002)

Õ Õ

Õ

Õ

Õ

Textile Industry

ˆ ˆ
 ˆ ˆ

....

()

() ∅

/	
ˆ ˆ ˆ ˆ) ˆ ˆ (

DRI (direct reduction iron)

Pig Iron

" \tilde{O} " \tilde{O} \tilde{O} .
 \tilde{O} \tilde{O} \tilde{O} .
 \tilde{O}
 \tilde{O} \tilde{O}

(Pouring)

()

:

()¹

:

flux \tilde{O}

)

.(

:

-
-
-

-
-
-

-

ō ō

/

-

-

•

ō () ō

-

()

ō ō ō ()

()

ō ō)

ō (

ō ō ō (Lances)

ō ō

ō ō

ō ō ō

ō ō

ō ō

ō

(lance)

-

ō

(bars,) \tilde{O} \tilde{O}
 \tilde{O} \tilde{O} \tilde{O} \tilde{O} rounds, slabs, billets, and blooms)
 \tilde{O}

° _ °

(CO, CO₂, SO₂, NO_x)

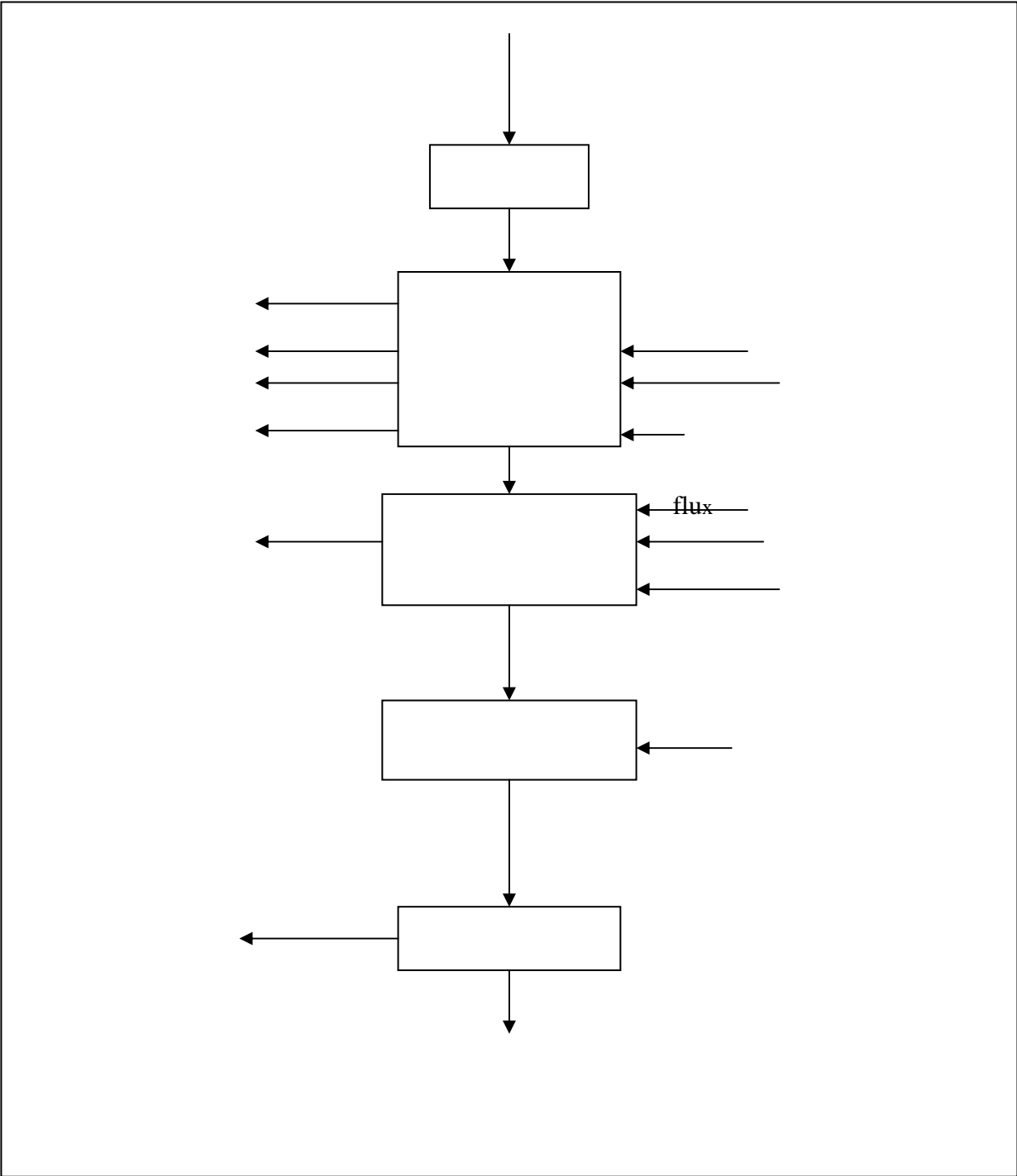

() Ø

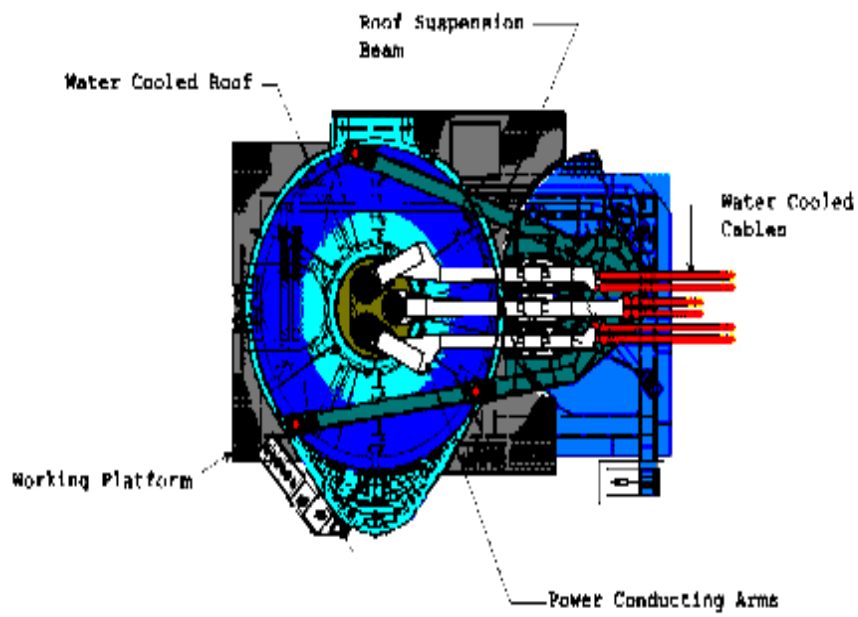
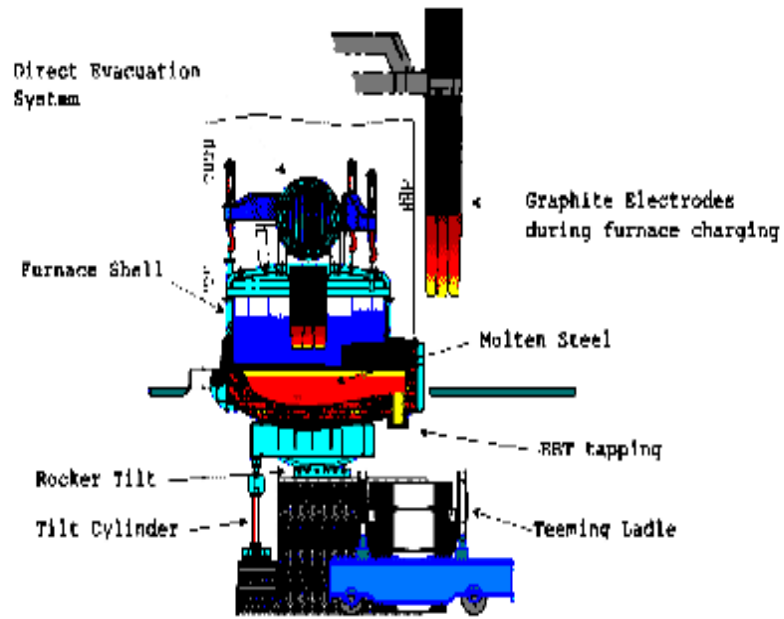

() Ø

õ õ õ

õ õ
õ () õ õ
õ

õ õ õ õ
õ õ õ õ
õ õ

õ õ õ ()
õ

õ õ õ
õ õ õ

õ ()

Õ Õ Õ

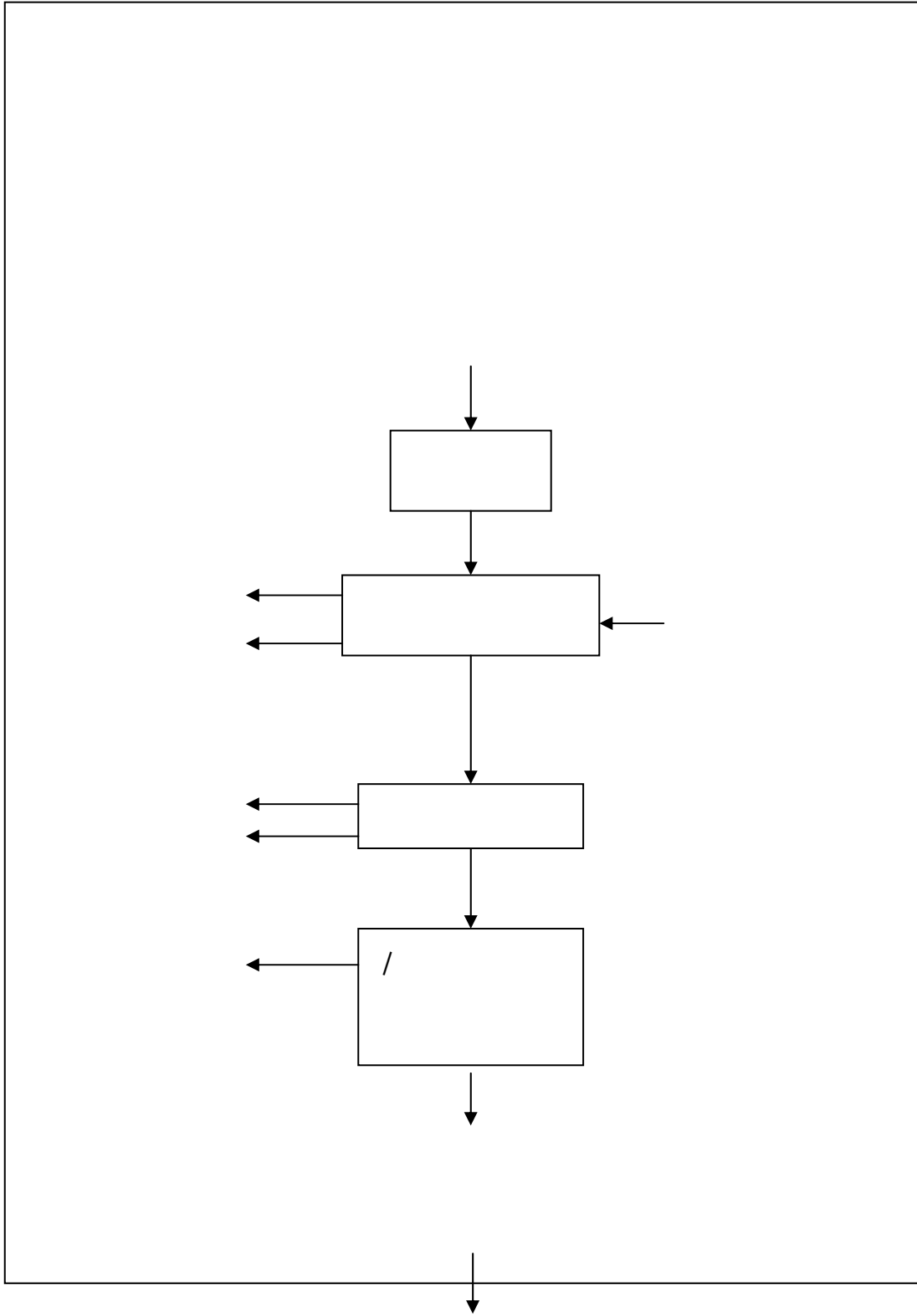

()

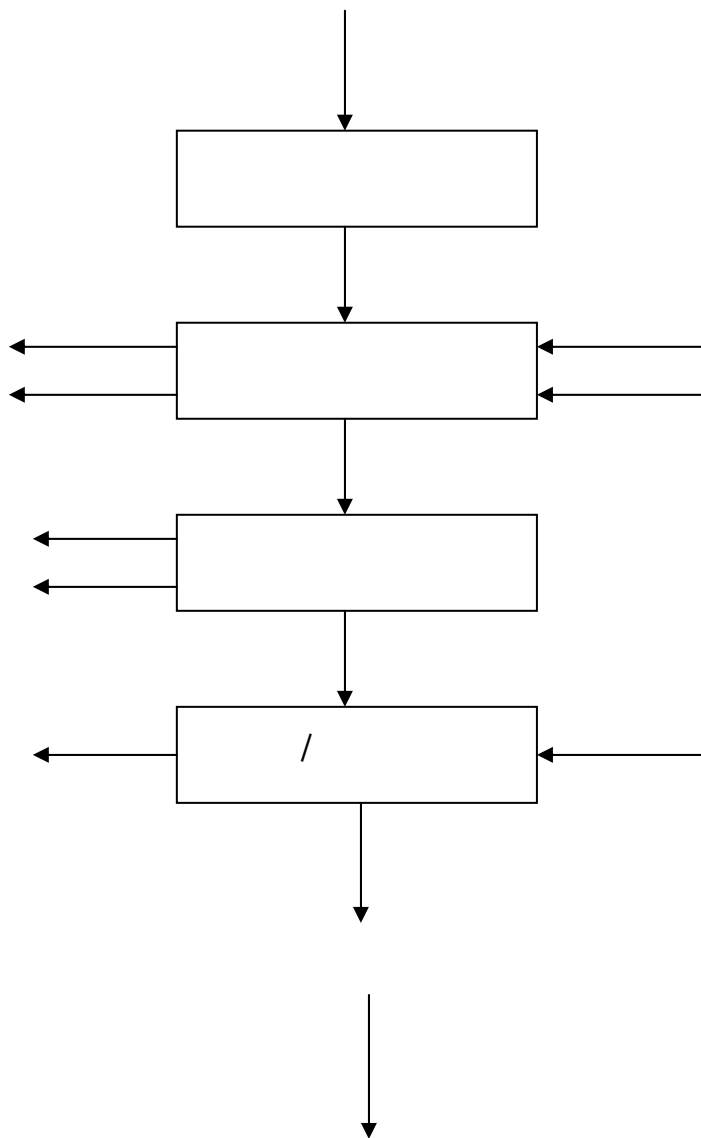

() Ø

- -

/

(tundish)

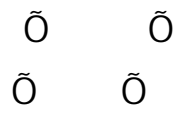
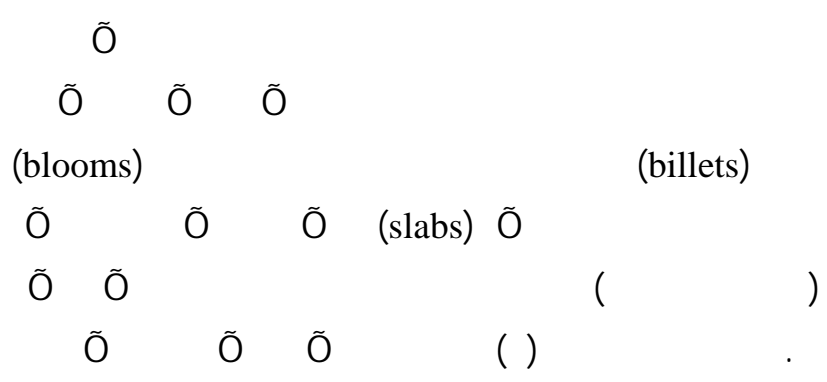

(tundish)

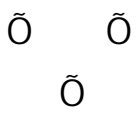
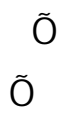

(flame cutters)

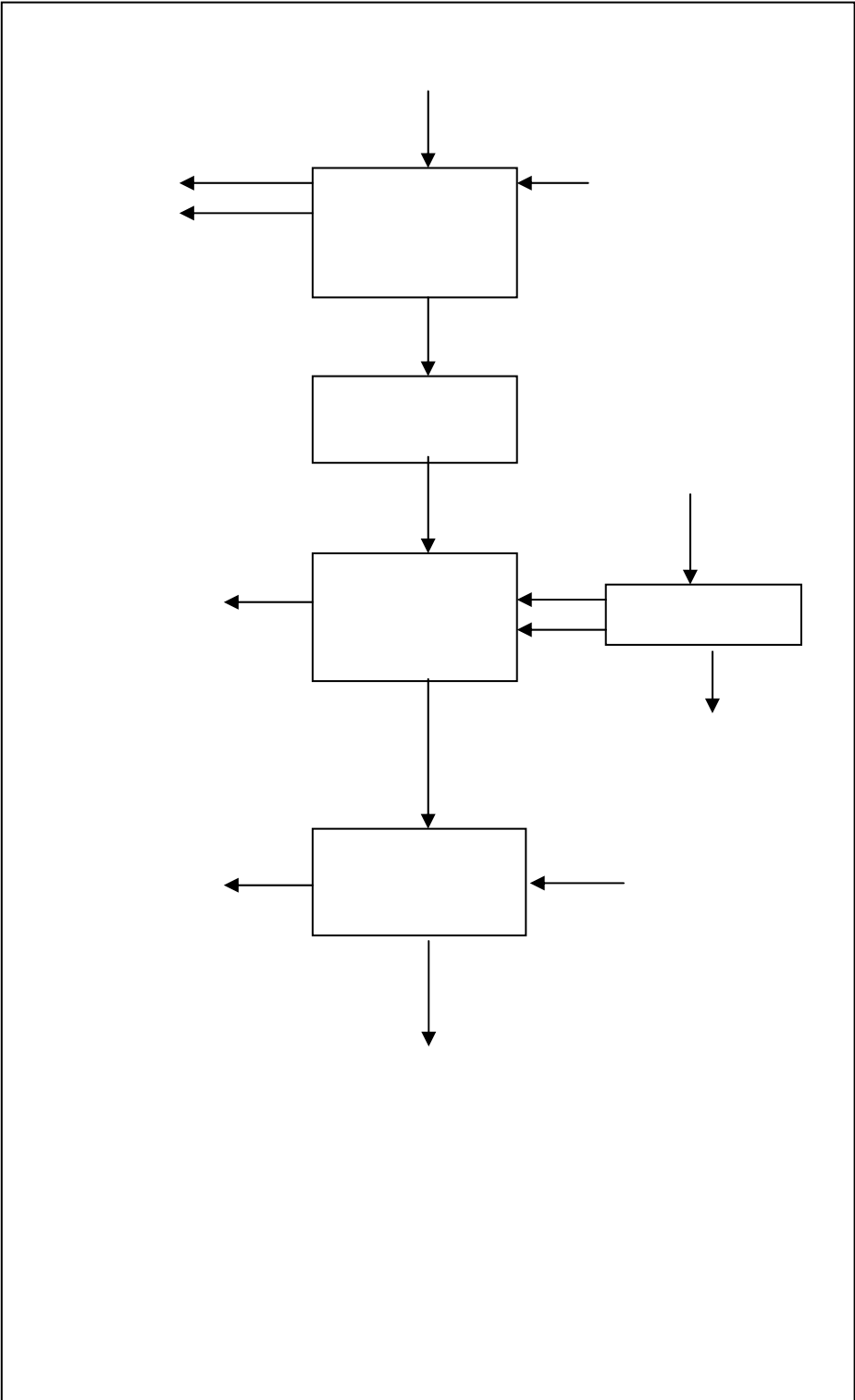

() Ø

- -
-

Õ

Õ Õ Õ

Õ Õ Õ

Õ Õ Õ . Õ Õ Õ % - % -

(sea coal) Õ

()

Õ Õ

Õ

Õ

Õ Õ Õ

Õ Õ

Õ Õ

Õ Õ Õ Õ

Õ

Õ Õ ()

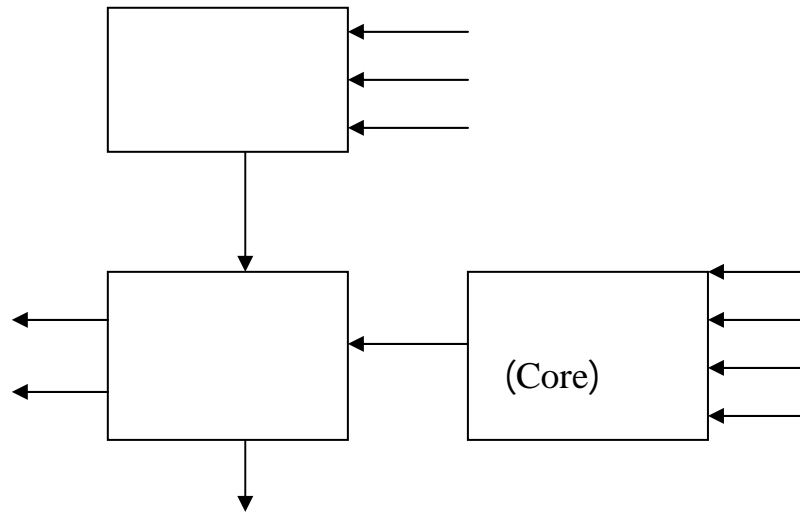

() ∅

$$\begin{pmatrix} \tilde{0} & \tilde{0} & \tilde{0} \\ \tilde{0} & \tilde{0} & \tilde{0} \\ \tilde{0} & & \end{pmatrix}$$

$$\begin{pmatrix} \tilde{0} & \tilde{0} & \tilde{0} \\ \tilde{0} & & \end{pmatrix}$$

Õ
Õ Õ
Õ
Õ Õ Õ Õ
Õ)
Õ Õ .
Õ Õ Õ
Õ

(

Õ Õ Õ
Õ
Õ .
Õ Õ

()

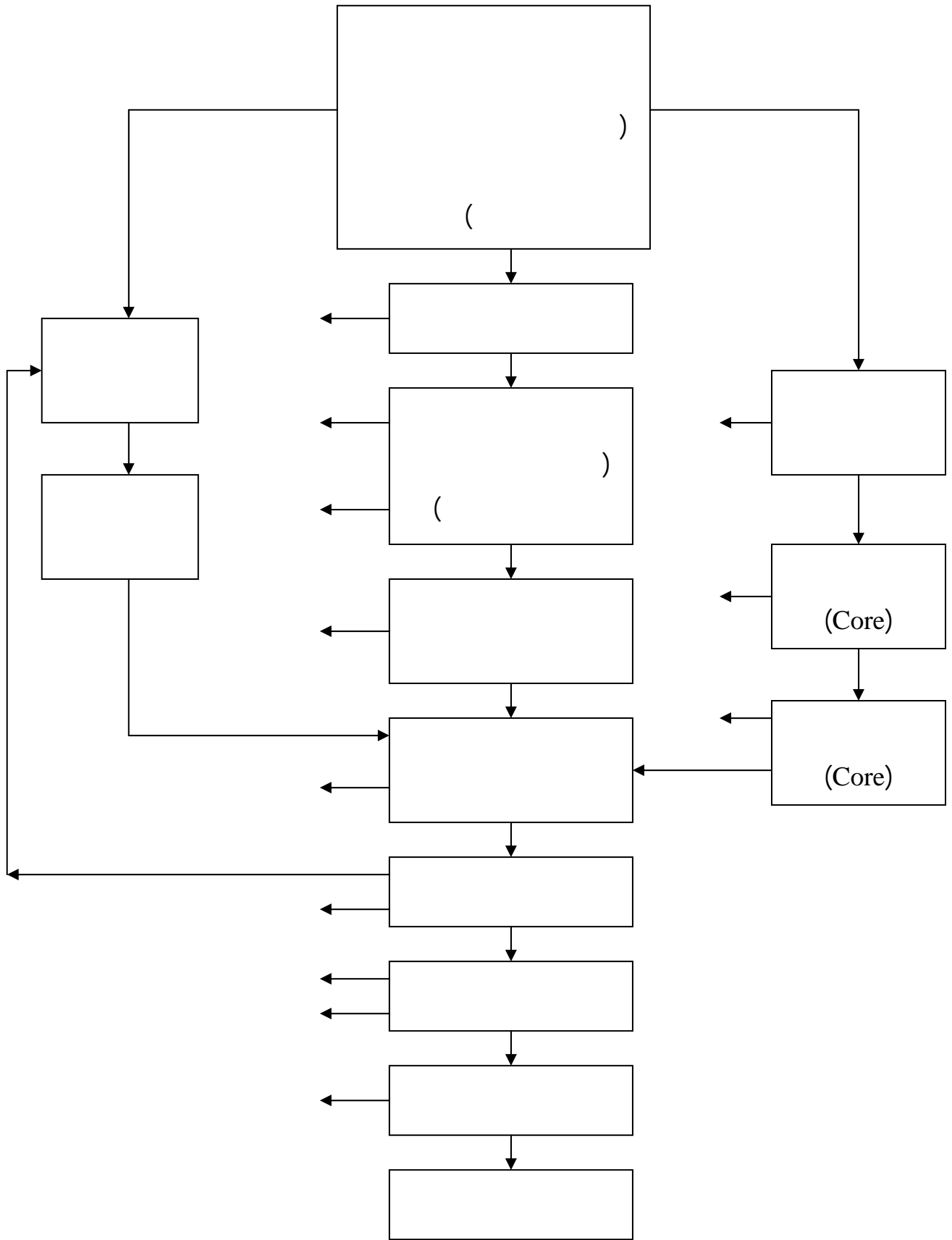

() Ø

-

ō ō
ō ō

ō ō
ō ō
ō ō ō

Ø

- -

ō ō ō
ō .
ō ō

:

ō (bars, slabs, blooms and billets)

•

•
ō ō ō o -

ō ō ō ()
ō ō

ō (slabs, bars, rounds, blooms and billets)

ō ō ō (ingot) /

ingot rolling

(soaking ()

ingots /

ō ō ō ō ingots ō / pits)

roughing

ō ° - ° ō ō
ō ō ō

ō

ō ō ()

ō

ō ō ō
ō

(\bar{O})
 \bar{O} \bar{O} .

()

\bar{O}
 \bar{O} \bar{O} \bar{O} v \bar{O}

\bar{O} \bar{O}
 \bar{O} .
 \bar{O} .

(Scales)

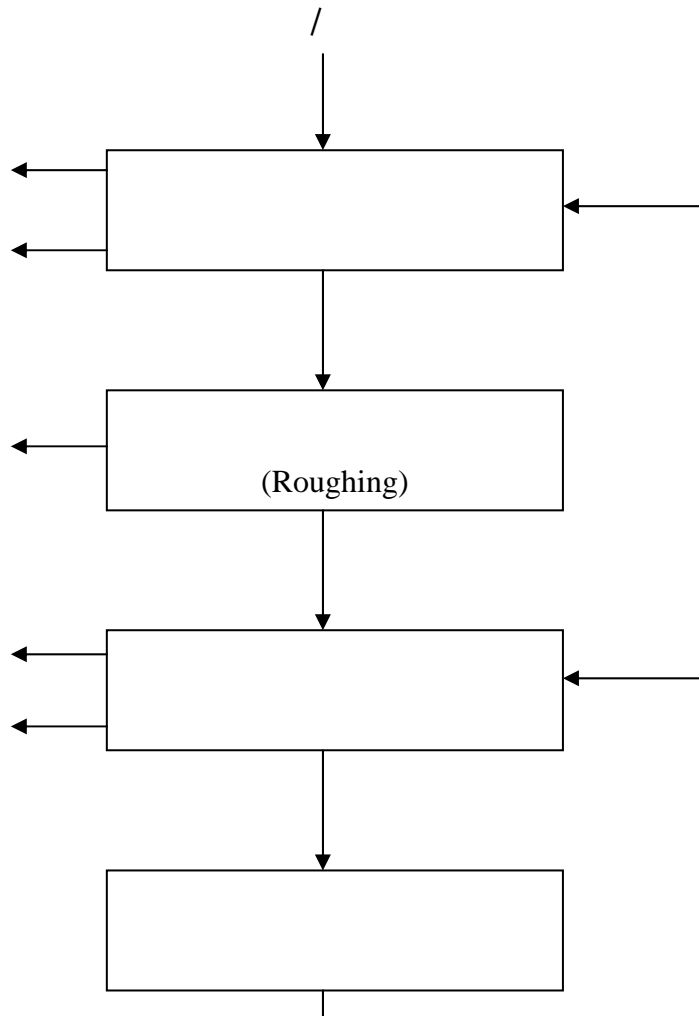

() Ø



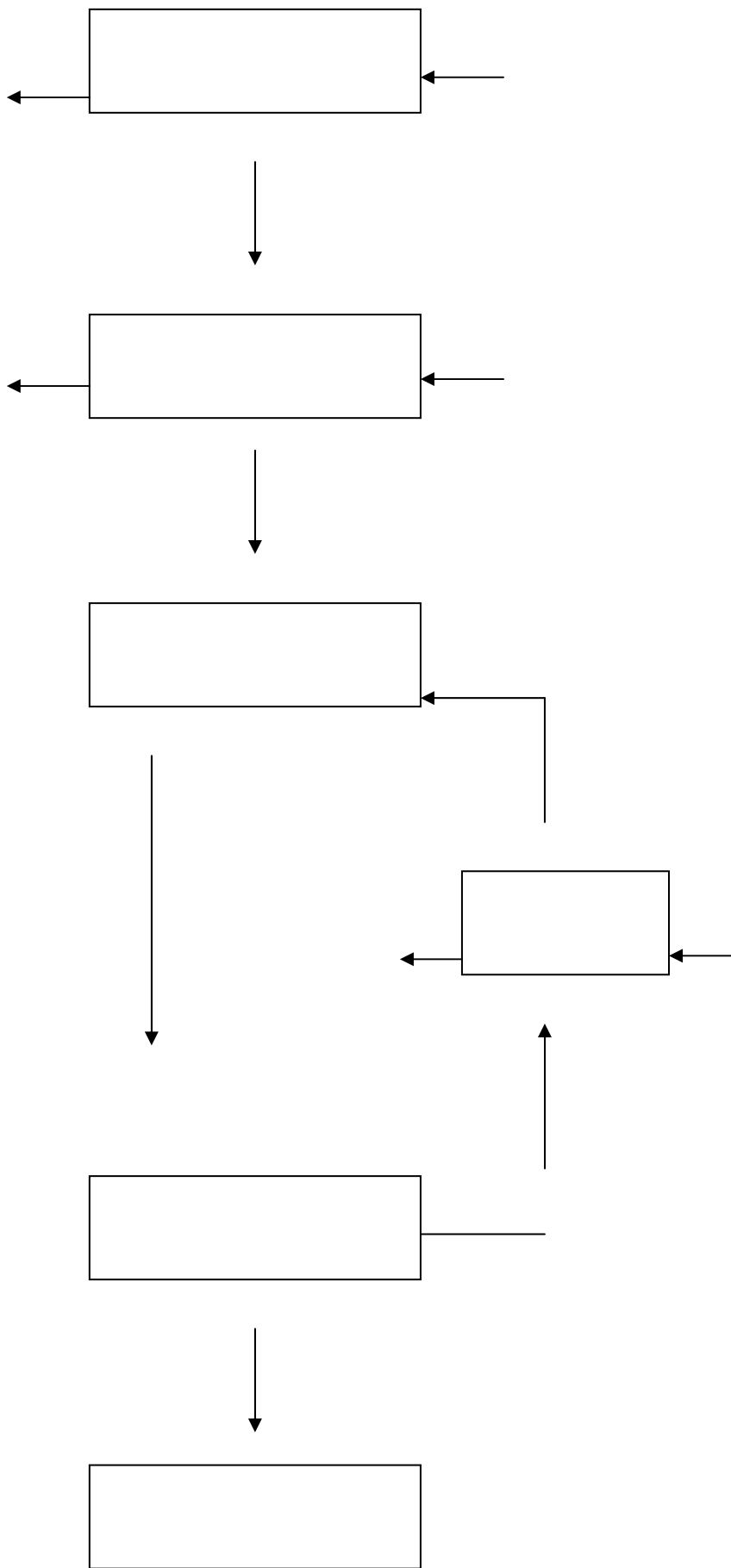



() ∅

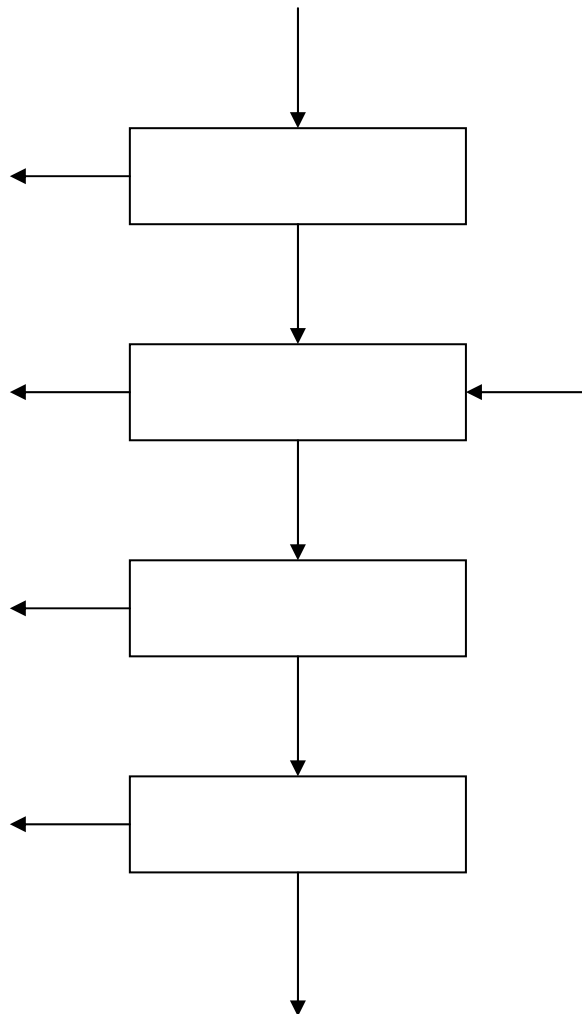

() Ø

-

--

()
ō (ō ō)
(ō)

ō
ō ō
) :

(
ō ō ō ō
ō ō ō ō
(pH) ō
ō

0

)

(

0

0

0

0

--

. (make-up water)

∅ - -

:

ō ō ō

. . . .

•
•
•

- -

:

ō ō

•
•
•
•

- -



Õ

Õ

•

•

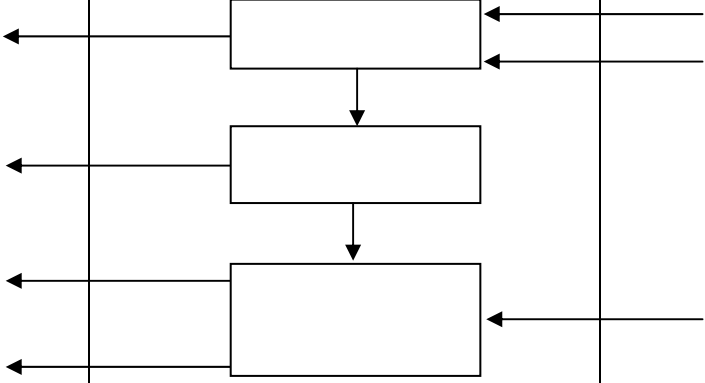
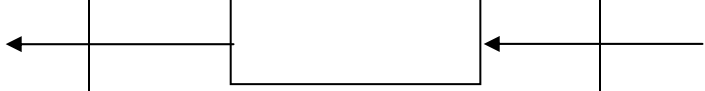
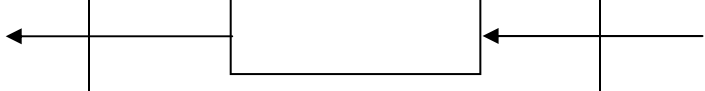
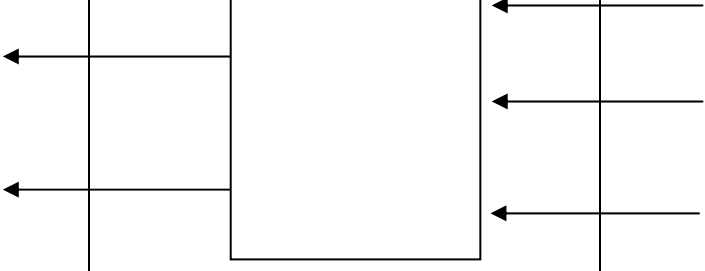
() Ø

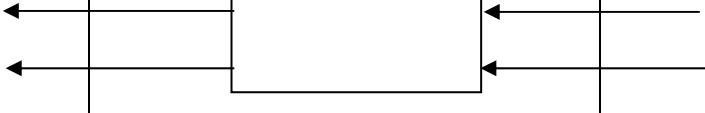
()		+
()		
()		
		
		
		

(tapping)

(rising plume)

0

()

() Ø

Ø	Ø
19 -0.5	(CO)
0.02 -0.3	(NOx)
0.15 -0.03	(VOC)
0.005 -0.05	(Pb)
0.3	(PM)

0 0

0 0 0

0 0 0

0 0 0 , ,) .

(, , ,

o

ō
ō ō)
ō ō (

ō ō
ō

ō ō

(furnace sput)

ō ō

(tapping)

ō ō . ō

ō ō

ō

slabs or) ō ō ō

ō

(blooms, bars, billets and rounds

- ō

o

ō

(CO, CO2, SO2, NOx)

(, - ,)
(%)

() ()
()

(/)	
() ,	
, - ,	
,	

ō
ō ō ō (rice hull)

ō
ō ō

ō
ō ō ō ()

ō ō

ō ō
ō ō ō
ō ō ō ō ō
ō ō ō
ō ō

ō

() Ø

) ((/)		
	,				
	,				
				()	
				000	
	,				
-	-	-	-		/ Õ / Õ
	,				

Õ

()

.

() Ø

	()	
		õ
	õ	
õ õ	-	
õõõ	-	õõõõ
õõ		
õ	-	õõõõ

- -

õ õ

ō ō
() ō
ō ō ō ō

ō ō
ō /

()
ō ō)
ō ō)
.(

--

() Ø

	ō ō ō ō ō ō ō ō ō ō	
ō ō ō ō ō ō	ō ō	(TDS)
		(TSS)
ō ō		()
ō		
ō ō ō ō ō ō ō) ō (
ō	ō ō ō	

-

-

()

() Ø

õ õ õ õ	
õ õ	
õ õ õ õ	
õ õ õ õ õ	
õ õ	

õ

Õ Õ

Õ Õ Õ

Ø

-

Õ Õ Õ

Õ Õ

Õ Õ

Õ Õ

Õ Õ

Õ Õ Õ Õ

Õ

Õ Õ Õ Õ

()

Ø

() Ø

Õ Õ	
	(TDS)
Õ Õ	(TSS)
Õ Õ Õ	
Õ Õ	

-

-

.
.
.

.()

.

:

-

()

:

ō

•

ō ō

•

.% ,

•

ō

ō ō ō ō

•

ō ō

•

ō ō ō ō

\tilde{O})
 \tilde{O} \tilde{O} (...

\tilde{O} •

\tilde{O} / •

()
 ()

() \emptyset

(/)		
		() ()

() \emptyset

	(/)			
			\emptyset	

-

.

()

)

.(

.

() Ø

:							
		Ø	Ø .	Ø) (/		(/)	
				>		()	
				>		COD	
-	-	-	-	, -	-	(pH)	
				>			
				> ()		()	
				>			
-	-		-	/	-		
				/			

() Ø ()

:						(/)	
		Ø	Ø .	Ø) (/			
-	-	-	-	-			
		,	,	,	,		
		-	-	-	-		
				,	-		
				,	,		
					,		
		,	,		,		
-	-			-			
			-		-		

-

:

•

ō ō
ō

•

ō ō ()

•

•

ō ō ō

•

∅

-

:

() /
ō

•

ō ō ō :
() ō ō
ō ()

•

Õ : •
 Õ Õ () ()
 . ()
 Õ Õ •
 Õ •
 Õ Õ Õ Õ •
 Õ Õ Õ Õ •

Ø () Ø

/		/		
				Ø
				Ø
				Ø

() Ø

		Ø
◦ ,	◦	
◦ ,	◦ ,	
◦ ,	◦ ,	

() Ø

() Ø	
	-
	-
	-
	-
	-

() Ø

					() Ø
					()

() Ø

Ø Ø	(Ø)
,	
,	

-

)

(

Ø

-

Õ

Õ

Õ

○ ○ ○
○
○ ○ ○

(fabric filter)

○ ○

(pulse jet baghouses)

○ ○
○
○
○ ○

(bagehouse hopper)

○
○
○ ○ ○

(scrubbers)

(sludge)

○
○ ○
○ ○
○ ○ ○
○ ○
○ ○
○

ō ō ō
ō
ō

ō

ø

-

ō ō
ō
ō

-

•

ō ō ō
ō ō
ō

()

ō ō ō ō ō ō ō
ō (after burner)

(incineration)

-

ō
ō ō

Õ Õ

Õ Õ Õ

Õ Õ Õ
 Õ Õ
Õ Õ

Õ Õ Õ Õ

Õ

Õ Õ Õ Õ

0)
0 0 (.
0 0
0 0 .

0 0 0 %
0 0
% - (mill scale)

(% -)
0
0 0

0

0 0
0
(% -)

Õ Õ Õ -
Õ Õ Õ Õ

Õ

-

()

() Ø

		()	
	-		-
\tilde{O} \tilde{O} ()	-		-
	-		-
	-	\tilde{O}	-
\tilde{O} \tilde{O} \tilde{O}	-		-
\tilde{O} \tilde{O} \tilde{O}	-		-
	-	$\tilde{O}\tilde{O}$ $\tilde{O}\tilde{O}$	-

\tilde{O}

\tilde{O}

\tilde{O} \tilde{O}

Õ Õ ()
(GIM EPAP 2002) Õ Õ Õ

-

-

õ ()
õ
õ õ

õ -
õ õ
õ õ
õ õ õ

-

õ
õ)
õ õ õ (.....

õ

-

()

-

Õ Õ (GIM EPAP 2002) Õ Õ

:

-
-
-

Õ Õ Õ Õ

Õ (Õ)

Õ

-

Õ Õ Õ

Õ .(-)

Õ Õ Õ ()

Õ .(GIM EPAP 2002)

:

-
-
-
-

.()

Õ Õ (-)

Õ Õ) Õ

(

-

(EPAP GIM 2002)

(O)

O O

:

O O O

•

O O

•

O O

O .(GIM EPAP 2002)

()

O O

•

O O O)

(

O O O

-

O

()

O

O O O

Õ Õ Õ Õ

:

ō ō :

ō

ō (ō ō ō)

ō ō (-)

ō ō

ō ō
ō ō ō

Õ Õ (GIM EPAP 2002)

Õ Õ

Õ Õ

Õ Õ

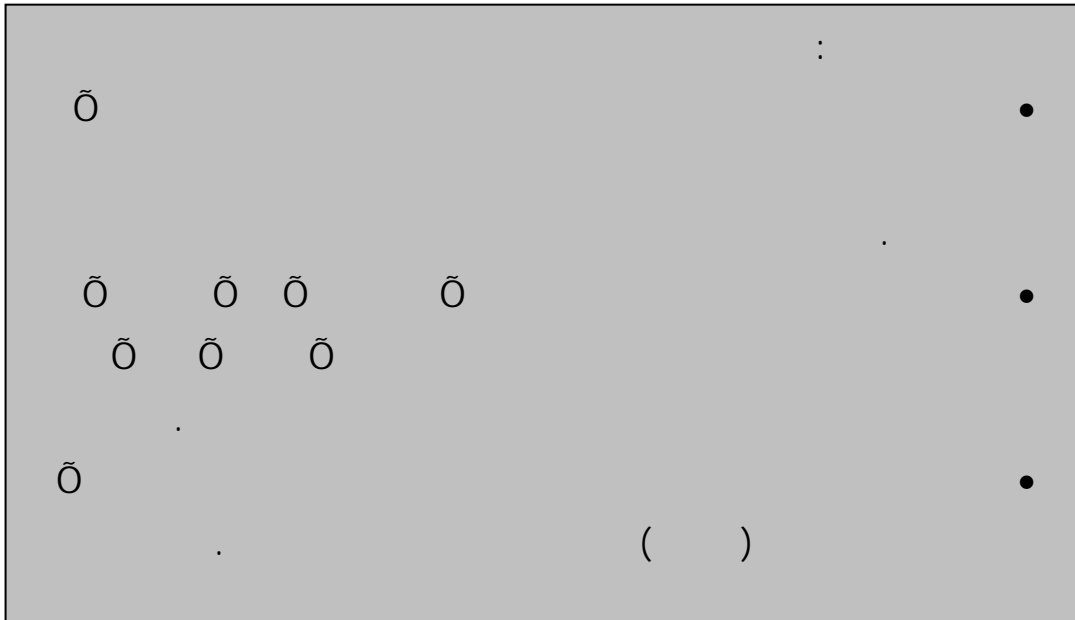

Õ
Õ Õ Õ Õ Õ () Õ Õ Õ
(GIM EPAP 2002)

Õ Õ Õ

Õ ()

Õ

Õ

Õ

Õ

)

(

:

Õ

Õ

Õ

Õ

Õ

Õ

/

Õ

Õ

Õ

Õ

Õ

Õ

.()

Õ

Õ

Õ

Õ

Õ

Õ

Õ

Õ

Õ

· -

· () -
() -

· -
· -
· -

-

)

-

.(

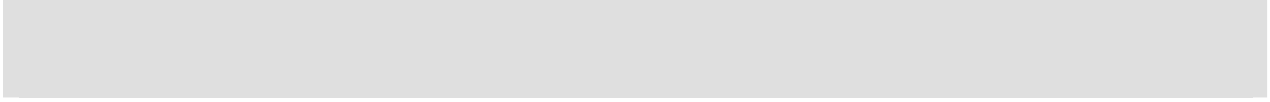

-

.

.

-

.

.

-

-

.

.

-

.

-

-

%

-

.

-

.

-

.

-

.

-

.

-

.

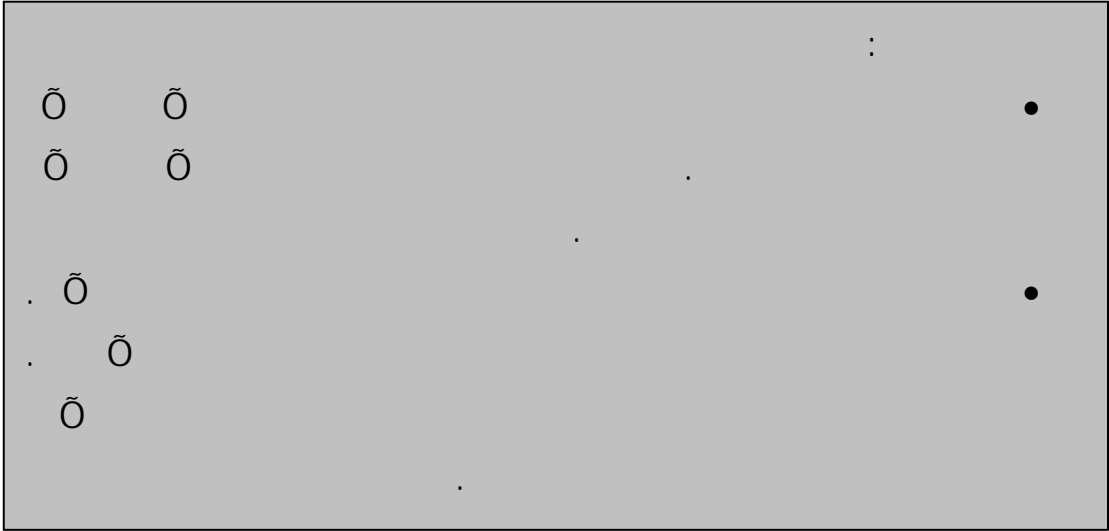

⊖ ⊖
⊖ ⊖

⊖ ⊖

⊖ ⊖ ⊖



Õ Õ Õ
Õ Õ
 Õ
Õ Õ Õ Õ

-
:
.

Õ (GIM EPAP 2002)
Õ Õ
Õ Õ Õ
Õ Õ

()

Õ Õ Õ

Õ Õ Õ

:

•

•

•

-

:

.

()

•

•

.

.()

•

()

(-)

()



----- :

----- :

----- :

----- :

----- :

----- :

----- : °

----- :

----- :

/

----- :

----- :

----- :

----- :

----- :

----- :

----- :

----- :

----- :

----- :

----- :

----- : /

----- :

----- :

----- :

----- :

----- : ----- :

----- :

/ ----- : /

/ ----- : /

----- :

:



:

(-) / . - - - - - :

(- -) / .	
- - - - -	
- - - - -	
- - - - -	
- - - - -	
- - - - -	

(Global Positioning System) GPS

- 1- LAT (Latitude) : 2- LAT (Latitude): 3- LAT (Latitude):
 LONG (Longitude): LONG (Longitude): LONG (Longitude):

:

(-) /	
- - - - -	- - - - -
- - - - -	- - - - -
- - - - -	- - - - -
- - - - -	- - - - -
- - - - -	- - - - -
- - - - -	- - - - -

:

() : - - () - ()



:

		Ø			
-----	-----	-----	-----	-----	()

() / ----- :

:

:

:

pH

() / ----- :

() / ----- :

:

:

(Global Positioning System) GPS

1-LAT (Latitude)

2-LAT(Latitude):

LONG (Longitude):

LONG (Longitude):

() : () - ()



LAT (Latitude):

LONG (Longitude):

() : - - () - ()



:

----- ----- ----- ----- ----- ----- ----- ----- ----- -----	----- ----- ----- ----- ----- ----- ----- ----- ----- -----

----- :

() : - - () - ()

(-)

() -						
						-
	(***)		(**)	Ø		(*)

(*)

/ (**)

:

/ (***)

:

:

:

:

() () -										
:										
()	∅	∅								
		/	()	()	() /	() /	∅			

/ ()



:

()

:

:

:

:

:

()

:

()

:

:

:

:

()

() :

:

()

(-)

-

-

-

□ □

o -

-----/-----/-----

-

-

-

□ □
□ □

o -
o -

.

-

:

∅ -

□ □

o -

Õ -

□ □

()
o -

□ □
□

-

----- □ □	o	-
□ □ / □	o	-
----- □ □	o	-
□ □	o	-
:		
----- ----- -----	o	-
-----	o	-
/ -----: -----:		-
-----		-
-----		-

		-
----- -----		-
-----		-
□ □	o	-
-----/-----/-----		-
----- ----- ----- -----		-
-----: / -----: / -----:		-
:		
		-
□ □ □ □	o o	-
.		
-----		-
:		
-----		-
		-
:		

Ø		-
<input type="checkbox"/> <input type="checkbox"/>		-
----- -----	Ö	-
----- <input type="checkbox"/> <input type="checkbox"/>) . o (-
<input type="checkbox"/> <input type="checkbox"/> <input type="checkbox"/>	.	-
----- <input type="checkbox"/> <input type="checkbox"/>		-
<input type="checkbox"/> <input type="checkbox"/> <input type="checkbox"/> /	o	-
----- <input type="checkbox"/> <input type="checkbox"/>		-
<input type="checkbox"/> <input type="checkbox"/>	o	-
		:
		-
---/------ --/------ --/------	o	-
-----	o	-
-----		-

-	
/ -----; -----;	-
-----	-
-----	-

		-
----- -----		-
<input type="checkbox"/> <input type="checkbox"/>	o	-
-----		-
		Ø -
----- <input type="checkbox"/> <input type="checkbox"/>	.()	-
<input type="checkbox"/> <input type="checkbox"/>	o	-
-----	.	-
----- <input type="checkbox"/> <input type="checkbox"/>	o	-
		:
		-
<input type="checkbox"/> ----- <input type="checkbox"/> -----	o	-
-----		-
-----	o	-
		-
-----		-
-----	o	-

-	
-----	() -
-----	-

∅

		-
----- -----		-
-----		-
-----:	o	-
-----:		-
		-
----- <input type="checkbox"/> <input type="checkbox"/>	o	-
-----		-
		:
		∅ -
-----		-
-----	o	-
----- -----	Õ Õ	-
	Õ Õ	-
-----		-
----- <input type="checkbox"/> <input type="checkbox"/>	o	-
----- <input type="checkbox"/> <input type="checkbox"/>	o	-
		:
		-
<input type="checkbox"/> ----- <input type="checkbox"/> -----	o	-

-----	-
-----	o -
-----	-
-----	-

----- -----	-
	-

		-
----- -----		-
<input type="checkbox"/> <input type="checkbox"/> <input type="checkbox"/>	o	-
		-
----- :(...) ----- :(...) ----- :(...)	o	-
		:
<input type="checkbox"/> <input type="checkbox"/> ----- <input type="checkbox"/> <input type="checkbox"/>		-
<input type="checkbox"/> <input type="checkbox"/>	o	-
		/
<input type="checkbox"/> <input type="checkbox"/>	o()	-
-----	.	-
		-
		∅
	.	-
	.	-
<input type="checkbox"/> <input type="checkbox"/>	o	-
		:
		-
/ -----	o	-
/ ----- / -----		-
<input type="checkbox"/> <input type="checkbox"/>	.	-

		-
<input type="checkbox"/>	<input type="checkbox"/>	o -
-----		o -
-----		o -
-----	Õ Õ	o -
		Ø -
-----		o -
<input type="checkbox"/>	<input type="checkbox"/>	/ / o -

()

		Ø -
-----		o -
-----	Õ Õ Õ	o -
		-
-----		o -
-----		o -
		Ø -
<input type="checkbox"/>	<input type="checkbox"/>	o -
<input type="checkbox"/>	<input type="checkbox"/>	o -
-----		o -
		.

Ø

		-
-----	°	-
-----	Ö Ö	-
		Ø -
□ □	/ /	-
-----	Ö Ö °	-
		Ø -
□ □	/	-
□ □	°	-
		-